

.6 cu. ft. Microwave Oven

MCM660A

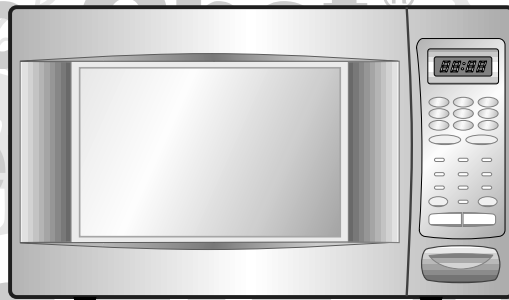

So Right at Home.

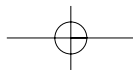

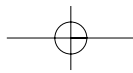
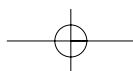
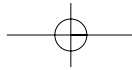

TABLE OF CONTENTS

1. PRECAUTIONS	2
2. IMPORTANT SAFETY INSTRUCTIONS	3
3. FEDERAL COMMUNICATIONS COMMISSION RADIO FREQUENCY	4
4. INTERFERENCE STATEMENT (U.S.A ONLY)	4
5. GROUNDING INSTRUCTIONS	4
6. INSTALLATION	5
7. USE YOUR MICROWAVE OVEN SAFELY	6
8. SPECIFICATIONS	7
9. FEATURES KEYPAD DIAGRAM	8
10. MICROWAVE UTENSILS	11
11. UTENSIL TEST	11
12. OPERATION	11
13. CONTROLS	12
A. SETTING THE CLOCK	12
B. WEIGHT DEFROSTING	12
C. TIME DEFROSTING	13
D. COOKING IN ONE STAGE	13
E. COOKING IN TWO STAGES	14
F. WEIGHT DEFROSTING AND COOKING IN TWO STAGES	14
G. AUTO START	15
H. TO CHECK AUTO START TIME	16
I. SPEEDY COOK	16
J. ONE TOUCH COOKING	16
K. MORE, LESS	19
L. CHILD SAFETY LOCK	19
M. TO STOP THE OVEN WHILE THE OVEN IS OPERATION	19
14. CARE OF YOUR MICROWAVE OVEN	20





PRECAUTIONS TO AVOID POSSIBLE EXPOSURE TO EXCESSIVE MICROWAVE ENERGY

- (a) Do not attempt to operate this oven with the door open since open-door operation can result in harmful exposure to microwave energy. It is important not to defeat or tamper with the safety interlocks.
- (b) Do not place any object between the oven front face and the door or allow soil or cleaner residue to accumulate on the sealing surfaces
- (c) Do not operate the oven if it is damaged.
 - * It is particularly important that the oven door close properly and that there is no damage to the following:
 - (I) door (bent),
 - (II) hinges and latches (broken or loosened),
 - (III) door seals and sealing surfaces.
- (d) The oven should not be adjusted or repaired by anyone except properly qualified service personnel.

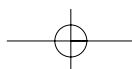

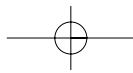

IMPORTANT SAFETY INSTRUCTIONS

When using electrical appliances, basic safety precautions should be followed, including the following:

WARNING-To reduce the risk of burns, electric shock, fire, injury to persons or exposure to excessive microwave energy:

- 1 Read all instructions before using the appliance.
- 2 Read and follow the specific "PRECAUTIONS TO AVOID POSSIBLE EXPOSURE TO EXCESSIVE MICROWAVE ENERGY" found on page 1.
- 3 This appliance must be grounded. Connect only to properly grounded outlet. See "GROUNDING INSTRUCTIONS" found on page 3.
- 4 Install or locate this appliance only in accordance with the provided installation instructions.
- 5 Some products such as whole eggs and sealed containers - for example, closed glass jars-may explode and should not be heated in this oven.
- 6 Use this appliance only for its intended use as described in this manual. Do not use corrosive chemicals or vapors in this appliance. This type of oven is specifically designed to heat, cook, or dry food. It is not designed for industrial or laboratory use.
- 7 As with any appliance, close supervision is necessary when used by children.
- 8 Do not operate this appliance if it has a damaged cord or plug, if it is not working properly, or if it has been damaged or dropped.
- 9 This appliance should be serviced only by qualified service personnel. Contact nearest authorized service facility for examination, repair or adjustment.
- 10 Do not cover or block any openings on the appliance.
- 11 Do not store this appliance outdoors. Do not use this product near water — for example, near a kitchen sink, in a wet basement, or near a swimming pool, and the like.
- 12 Do not immerse cord or plug in water.
- 13 Keep cord away from heated surfaces.
- 14 Do not let cord hang over edge of table or counter.
- 15 Either:
 - a) When cleaning surfaces of door and oven that comes together on closing the door, use only mild, non-abrasive soaps or detergents applied with a sponge or soft cloth , or
 - b) When separate cleaning instructions are provided, See door surface cleaning instructions on (specific page or section to be included).
- 16 To reduce the risk of fire in the oven cavity:
 - a) Do not overcook food. Carefully attend appliance if paper, plastic, or other combustible materials are placed inside the oven to facilitate cooking.
 - b) Remove wire twist-ties from paper or plastic bags before placing bag in oven.
 - c) If materials inside the oven should ignite, keep oven door closed, turn oven off, and disconnect the power cord, or shut off power at the fuse or circuit breaker panel.
 - d) Do not use the cavity for storage purposes. Do not leave paper products, cooking utensils, or food in the cavity when not in use.
- 17 Do not use this microwave oven to heat corrosive chemicals (for example, sulfides and chlorides). Vapours from such corrosive chemicals may interact with the contact and springs of the safety interlock switches thereby rendering them inoperable.
- 18 Keep the waveguide cover clean at all times. Wipe the oven interior with a soft damp cloth after each use. If you leave grease or fat anywhere in the cavity it may overheat, smoke or even catch fire when next using the oven.
- 19 Never heat oil or fat for deep frying as you cannot control the temperature and doing so may lead to overheating and fire.

SAVE THESE INSTRUCTIONS

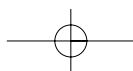

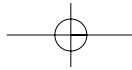

FEDERAL COMMUNICATIONS COMMISSION RADIO FREQUENCY INTERFERENCE STATEMENT (U.S.A ONLY)

WARNING:

This equipment generates and uses ISM frequency energy and if not installed and used properly, that is in strict accordance with the manufacturers instructions, may cause interference to radio and television reception.

It has been type tested and found to comply with limits for an SM equipment pursuant to part 18 of FCC rules, which are designed to provide reasonable protection against such interference in a residential installation.

However, there's no guarantee that interference will not occur in a particular installation.

If this equipment does cause interference to radio or television reception, which can be determined by turning the equipment off and on, the user is encouraged to try to correct the interference by one or more of the following:

- Re-orient the receiving antenna of radio or television.
- Relocate the microwave oven with respect to the receiver. Move the microwave oven away from the receiver.
- Plug the microwave oven into a different outlet so that the microwave oven and receiver are on different branch circuits.

THE MANUFACTURER is not responsible for any radio or TV interference caused by UNAUTHORIZED MODIFICATION to this microwave oven. It is the responsibility of the user to correct such interference

GROUNDING INSTRUCTIONS

This appliance must be grounded. In the event of an electrical short circuit, grounding plug reduces the risk of electric shock by providing an escape wire for electric current. This appliance is equipped with a cord having a grounding wire with a grounding plug. The plug must be plugged into an outlet that is properly installed and grounded.

WARNING:

Improper grounding can result in a risk of electric shock.

Consult a qualified electrician or serviceman if the grounding instructions are not completely understood, or if doubt exists as to whether the appliance is properly grounded, and either:

- (1) If it is necessary to use an extension cord, use only an extension cord that has a 3-blade grounding plug, and a 3-slot receptacle that will accept the plug on the appliance. The marked rating of the extension cord shall be equal to or greater than the electrical rating of the appliance, or
- (2) Do not use an extension cord, if the power supply cord is too short, have a qualified electrician or serviceman install an outlet near the appliance.

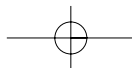

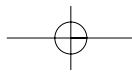

INSTALLATION

1 Examine the oven after unpacking

Check for damage such as a mis-aligned door, broken door or a dent in the cavity. If any damage is visible, DO NOT INSTALL, and notify your dealer immediately.

2 Level, flat location

Install the microwave oven on a level, flat surface.

3 Ventilation

Do not block air vents. If they are blocked during operation, the oven may overheat and eventually cause a failure. For proper ventilation, allow 3 inches of space between oven top, sides, rear and adjacent surfaces

4 Away from radio and TV sets

Poor television reception and radio interference may result if the oven is located close to a TV, radio, antenna, etc. Place the oven as far from them as possible.

5 Away from heating appliances and water taps

Keep the oven away from heat, steam or splashing liquids. These things can adversely affect oven wiring and contacts.

6 Power supply

This microwave oven requires a power supply of approximately 15 Amperes, 120 Volts, 60Hz and a grounded outlet. A short power cord is provided to reduce the risk of the user becoming entangled in or tripping over a longer cord. Longer cord sets or extension cords are available and may be used if care is exercised.

If an extension cord is used, the marked electrical rating of the cord should be at least as great as the electrical rating of the oven. The extension cord must be a grounding type 3-wire cord. The longer cord should be arranged so it does not drape over the tabletop or counter where children can pull on it or trip over it.

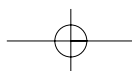

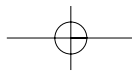

USE YOUR MICROWAVE OVEN SAFELY

GENERAL USE

Do not attempt to defeat or tamper with safety interlocks.

Do not place any object between the oven front frame and the door or allow residue to build up on the sealing surfaces. Wipe with mild detergent, rinse and dry. Never use abrasive powders or pads.

Do not subject the oven door strain or weight such as a child hanging on an open door. This could cause the oven to fall forward resulting in injury to you and damage to the oven.

Do not operate the oven if door seals or seals surfaces are damaged or if door is bent; or if hinges are loose or broken.

Do not operate the oven empty. This will damage the oven.

Do not attempt to dry clothes, newspapers or other materials in the oven they may catch on fire.

Do not use recycled paper products as they may contain impurities, which may cause sparks or fires.

Do not hit or strike the control panel with hard objects. This can damage the oven.

FOOD

Never use your microwave oven for home canning. The oven is not designed for proper home canning. Improperly canned food may spoil and be dangerous to consume.

Always use the minimum recipe cooking time. It is better to undercook rather than overcook foods. Undercooked foods can be returned to the oven for more cooking. If food is overcooked, nothing can be done.

Heat small quantities of food or foods with low moisture carefully. These can quickly dry out, burn or catch on fire.

Do not heat eggs in the shell. Pressure may build up and eggs can explode.

Potatoes, apples, egg yolks and sausages are examples of food with non-porous skins. These must be pierced before heating

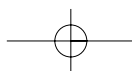

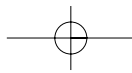

SPECIFICATIONS

POWER SUPPLY		120V AC 60 Hz SINGLE PHASE WITH GROUNDING
MICROWAVE	POWER CONSUMPTION	920 W
	OUTPUT POWER	600 W (IEC 705)
	FREQUENCY	2450 MHz
OUTSIDE DIMENSIONS (W X H X D)		465 X 274 X 352 mm (18.3 X 10.8 X 13.9 in.)
CAVITY DIMENSIONS (W X H X D)		290 X 200 X 290 mm (11.4 X 7.9 X 11.4 in.)
NET WEIGHT		APPROX. 13.5 KG (29.7 lbs.)
TIMER		59 min. 99 sec.
POWER LEVELS		10 LEVELS

* Specifications subject to change without notice.

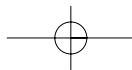
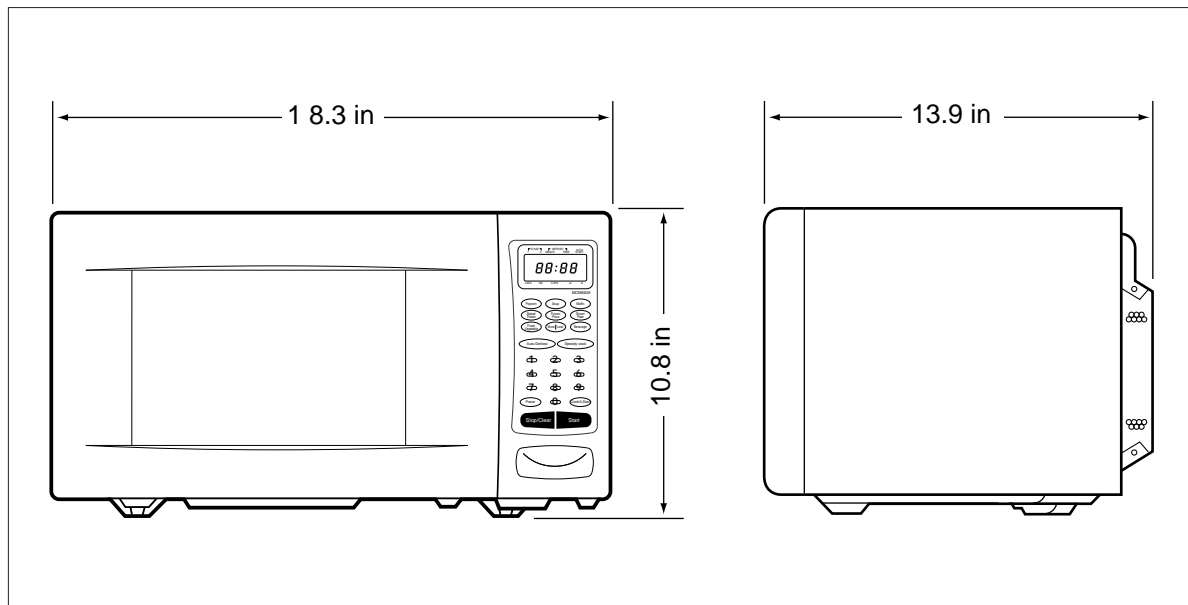

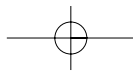

FEATURES DIAGRAM

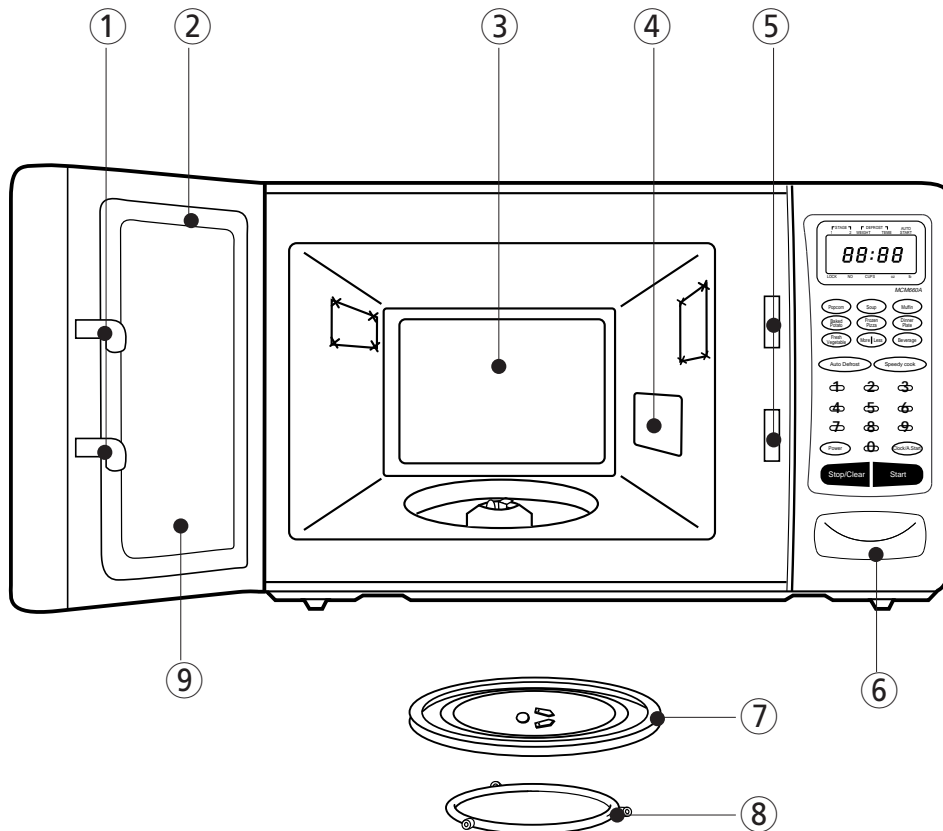

1. **Door latch** - When the door is closed it will automatically lock shut. If the door is opened while the oven is operating, the magnetron will automatically shut off.
2. **Door seal** - The door seal maintains the microwaves within the oven cavity and prevents microwave leakage.
3. **Oven cavity**
4. **Spatter shield** - Protects the microwave outlet from splashes of cooking foods
5. **Safety interlock system** - Prevents the oven from operating while the door is opened.
6. **Door release button** - Pushing this button stops oven operation and opens the door
7. **Glass cooking tray** - Made of special heat resistant glass. The tray must always be in proper position before operating. Do not cook food directly on the tray.
8. **Roller guide** - Supports the glass cooking tray
9. **Door screen** - Allows viewing of food. The Screen is designed so that light can pass through, but not the microwaves.

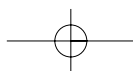

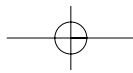

KEYPAD DIAGRAM

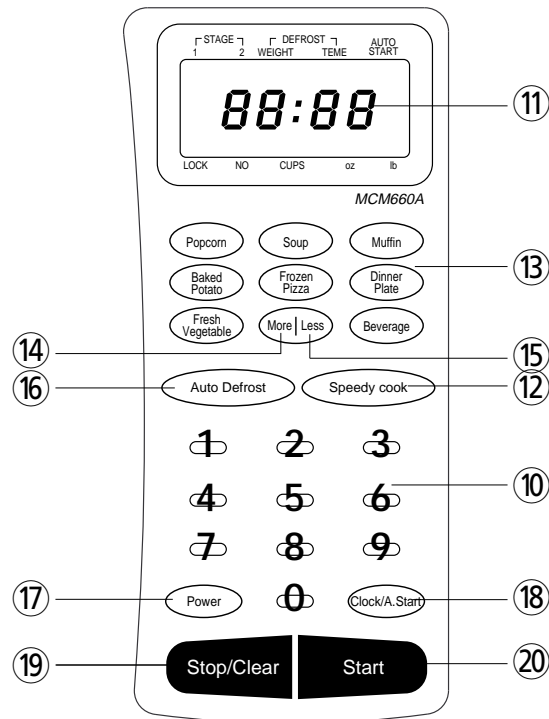

- 10. Time set pad** - Used to set the cooking time and the present time.
- 11. Display** - Cooking time, power level, indicators and present time are displayed.
- 12. Speedy cook** - Touch to set the desired reheat time.
- 13. One touch** - Used to cook or reheat specific quantities of food. See pages 16~18.
- 14. More** - Used to add time to one touch cooking.

- 15. Less** - Used to remove time from one touch cooking.
- 16. Auto defrost** - Used to defrost foods.
- 17. Power** - Used to set power level.
- 18. Clock/A.start** - Used to set clock and also used to set a delayed auto start.
- 19. Stop/Clear** - Used to stop the oven operation or to delete the cooking data.
- 20. Start** - Used to start the oven.

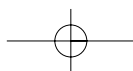

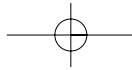

MICROWAVE UTENSILS

Glass, Ceramic and China

Ovenproof glass or ceramic baking dishes are the most used microwave utensils.

Many of these items are readily available in most homes: glass measure custard cups, mixing bowls, covered casseroles, pie plates and round or square cake dishes. Ovenproof dinnerware is usually safe to use in the microwave.

Do not heat or cook in glass jars or bottles.

Do not use dishes with silver gold, platinum or other metal trim. Arcing may occur and/or the dish may break.

Do not use delicate or stemmed glassware. Although the glass may be transparent to microwave energy, heat from the food may cause the glassware to crack.

Plastics

Plastic dishes, cups, mugs and bowls may be used in the oven for short periods of time. None of these should be used in the oven for prolonged periods because distortion and melting may occur. Check manufacturer's recommendations concerning microwave safety.

Plastic wrap can be used to cover dishes in most recipes if the dish is deep enough to avoid plastic wrap touching the food. Always vent the wrap by folding back one corner to allow excess steam to escape.

Plastic cooking bags should be slit before cooking so excess steam can escape.

Do not use wire twist ties to close the bag. Wire twist ties can cause arcing which can damage the oven.

Paper

Paper cups, wax paper, napkins, paper towels, and plates may be used for short cooking. Prolonged time in the oven can cause paper to burn. Do not use recycled paper products, such as brown paper bags. They contain impurities, which may cause arcing and damage the oven

Metal

Metal utensils should not be used in the oven. Metal reflects microwave energy so foods will not cook evenly.

Metal can cause arcing and damage the oven.

UTENSIL TEST

Dishes that do not absorb microwave energy are best for microwave cooking. Look on the label to verify that particular cups, glasses, plates are indeed suitable, especially paper goods. If you are not sure, try this utensil test to check

- Put the empty utensil in the microwave oven.
- Put one cup of water in a glass measure next to the empty utensil.
- Heat on HI for 1 minute.
- After 1 minute, the water should be warm but the utensil should not. If the utensil is warm. It is not suitable for microwave cooking

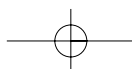

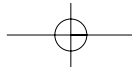

OPERATION

This section includes useful information about oven operation.

1. Plug power supply cord into a standard 3 pronged 15 Amp, 120V AC 60Hz power outlet.
2. Place the food in a suitable container.
3. Open the oven door and put the food on the glass tray. (The glass tray and roller guide must always be in place during cooking.)
4. Close the door firmly.

- The oven light is on only when the microwave oven is operating.
- The oven door can be opened at any time during operation by touching the door release button on the control panel. The oven will automatically shut off.
- Each time a pad is touched, a BEEP will sound to acknowledge the touch.
- The oven automatically cooks on full power unless set to a lower power level.
- Make sure the oven is properly installed and plugged into the electrical outlet.
- The Display will show “:0” when the oven is plugged in.
- Time Clock returns to the present time when the cooking time ends.
- When the STOP/CLEAR pad is touched during the oven operation, the oven stops cooking and all information is retained. To erase all information (except the present time), touch the STOP/CLEAR pad once more. If the oven door is opened during the oven operation, all information is retained.
- If the START pad is touched and the oven does not operate, check the area between the door and door seal for obstructions and make sure the door is closed securely. The oven will not start cooking until the door is completely closed or the program has been reset.

WATTAGE OUTPUT CHART

- Pressing the POWER pad sets the power-level. The chart shows the display, the power level and the percentage of power.

Touch POWER pad, Once the Touch	Power Level (Display)	Approximate Percentage of Power
POWER	P-HI	100%
9	P-90	90%
8	P-80	80%
7	P-70	70%
6	P-60	60%
5	P-50	50%
4	P-40	40%
3	P-30	30%
2	P-20	20%
1	P-10	10%
0	P-0	0%

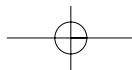

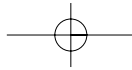

CONTROLS

SETTING THE CLOCK

When the oven is first plugged in, the display will flash ":0" and a tone will sound. If the AC power ever goes off, the display shows ":0" when the power comes back on.

1. Touch  pad.

This is a 12 hour clock system.

2. Touch  pad once more.

NOTE: This oven has multiple clock system. If you want 12 hour clock system, omit this step (step 2).

3. Enter

1	2	3
4	5	6
7	8	9
	0	

the correct time of day by touching the numbers in sequence.

4. Touch  pad.

The display stops blinking, and the colon start blinking. If you selected 12 hour clock system, this digital clock allows you to set from 1:00 to 12:59. If you selected 24 hour clock system, this digital clock allows you to set from 0:00 to 23:59.

NOTE: If you attempt to enter an incorrect time, the time will not be set and a error signal tone will sound. Touch the CLOCK/A.START pad and re-enter the time.

WEIGHT DEFROSTING

WEIGHT DEFROST lets you easily defrost food by eliminating guesswork in determining defrosting time. The minimum weight for WEIGHT DEFROST is 0.5 pounds. The maximum weight for WEIGHT DEFROST is 6.5 pounds. Follow the steps below for easy defrosting.

1. Touch  pad.

The WEIGHT DEFROST indicator lights and "0.0" is displayed and the g indicator starts blinking.

2. Touch

1	2	3
4	5	6
7	8	9
	0	

The display will show the numbers you pressed in the order you touched.

pads for the desired defrosting weight.

3. Touch  pad.

WEIGHT DEFROSTING begins.

The defrosting time is automatically determined by the weight entered. The lb indicator goes off and the weight defrost indicator blinks and the defrosting time counts down in the display window. The oven beeps during the defrosting cycle to signal that the food needs to be turned or rearranged. When the defrosting time ends, you will hear 3 beeps.

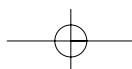

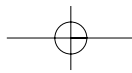

TIME DEFROSTING

When TIME DEFROST is selected, the automatic cycle divides the defrosting time into periods of alternating defrost and stand times by cycling on and off.

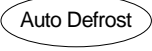
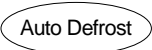
1. Touch  pad. The WEIGHT DEFROST indicator lights and "0.0" is displayed and the g indicator starts blinking.
2. Touch  pad once more. The TIME DEFROST indicator lights and ":0" is displayed.
3. Touch

1	2	3
4	5	6
7	8	9
	0	

 pads, for the desired defrosting time. The display will show the numbers you pressed in the order you touched.
4. Touch  pad. When you touch START pad, the TIME DEFROST indicator starts blinking to show the oven is in the TIME DEFROST mode. The display counts down the time to show you how much defrosting time is left in the TIME DEFROST mode. The oven beeps during the defrosting cycle to signal that the food needs to be turned or rearranged. When the defrosting time ends, you will hear 3 beeps.

COOKING IN ONE STAGE

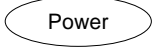
1. Touch  pad. The STAGE1 indicator lights and "P-" is displayed.
2. Touch

1	2	3
4	5	6
7	8	9
	0	

 pad for desired power level. This display will show what you touched. This example shows power level 3.
Note: If steps 1 and 2 are omitted, the oven will cook at full power.
3. Touch number pads for the cooking time. The display will show the numbers you pressed in the order you touched.
Note: Your oven can be programmed for 59 minutes 99 seconds.(59:99)
4. Touch  pad. When you touch START pad, the STAGE1 indicator starts blinking to show the oven is cooking. The display counts down the time to show how much cooking time is left. When the cooking time ends, you will hear 3 beeps.

NOTE: Using lower power levels increases the cooking time which is recommended for foods such as cheese, milk and slow cooking of meats.

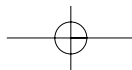

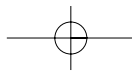

COOKING IN TWO STAGES

For best results, some recipes call for one power level for a certain length of time and another power level for a different length of time. Your microwave oven can be set to change from one to another.

1. Touch

1	2	3
4	5	6
7	8	9
	0	

The STAGE1 indicator lights and the display will show the numbers you pressed in the order you touched. This example begins at full power.

pads for the desired cooking time in the first stage.

2. Touch  pad.

The STAGE2 indicator lights and "P- " is displayed.

3. Touch the number pads for the power level you want in the second stage.

The display will show what you touched.

4. Touch the number pads for desired cooking timer in the second stage.

The display will show the numbers you pressed in the order you touched.

5. Touch  pad.

When you touch START pad, both STAGE 1 & 2 indicator lights come on, STAGE 1 indicator light starts blinking to show you that the oven is cooking in the first of two cook stages. The oven will cook at the power you selected for stage one. At the end of stage one, the oven will beep and start stage two, the STAGE 1 indicator goes off and the STAGE 2 indicator starts blinking. The display counts down the time remaining in stage two when stage two ends, you will hear 3 beeps.

WEIGHT DEFROSTING AND COOKING IN TWO STAGES

All recipes require frozen foods to be defrosted fully before cooking. This oven can be programmed to automatically defrost foods before cooking.

1. Touch  pad.

The WEIGHT DEFROST indicator lights and "0.0" is displayed and the lb indicator starts blinking.

2. Touch

1	2	3
4	5	6
7	8	9
	0	

The display will show the numbers you pressed in the order you touched.

pads for the defrosting weight you want.

3. Touch  pad.

The STAGE1 indicator lights and "P- " is displayed.

4. Touch  pad once more.

"P-HI" will appear in the display window. This example shows full power (100%).

5. Touch number pads, for desired cooking time in the first stage.

The display will show the numbers you pressed in the order you touched.

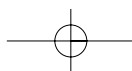

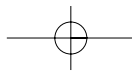

WEIGHT DEFROSTING AND COOKING IN TWO STAGES (CONTINUED)

6. Touch  pad.

The STAGE2 indicator lights and "P-" is displayed.

7. Touch

1	2	3
4	5	6
7	8	9
	0	

The display will show what you touched.

pads for the power level you want in the second stage.

8. Touch the number pads for the cooking time you want in the second stage.

The display will show the numbers you pressed in the order you touched.

9. Touch  pad.

When you touch START pad, the WEIGHT DEFROST, STAGE1 and STAGE2 indicators come on to confirm the power levels selected. The WEIGHT DEFROST indicator starts blinking to show you that the oven is in WEIGHT DEFROST mode. The display counts down the time remaining in WEIGHT DEFROST mode. When the oven beeps, turn over, break a part and redistribute at a beep. At the end of WEIGHT DEFROST mode, the oven will beep and start stage one. The WEIGHT DEFROST indicator goes off and the STAGE 1 indicator starts blinking. The display counts down the time remaining in stage one. At the end of stage one, the oven will beep and start stage two. The STAGE1 indicator goes off and the STAGE2 indicator starts blinking. The display counts down the time remaining in stage two when stage two ends, you will hear 3 beeps.

AUTO START

Auto start can be programmed for up to two cooking stages.
Auto start can not be programmed for auto defrost.

1. Program the desired power level and cooking time for food to be cooked.

2. Touch  pad.

The AUTO START indicator lights and ":0" is displayed.

3. Enter the desired start time by pressing the number.

The display will show the numbers you press pads in the order you touched.

4. Touch  pad.

When you touch START pad, the present time appears in the display and the cooking program indicators come on. The AUTO START indicator and the colon start blinking. When the selected start time arrive, the oven begins operating and the oven light turns on. The AUTO START indicator goes off and the next stage indicator begins to blink. When the cooking is completed you will hear 3 beeps. The oven turns off and the present time appears in the display.

NOTE: AUTO START can be used for time cooking, if the clock is set. If the oven door is opened after programming AUTO START, it is necessary to touch the START pad for the time of day to appear in the readout so that the oven will automatically begin programmed cooking at the chosen AUTO START time. Before setting, check to make sure the clock is showing the correct time of day.

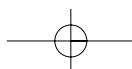

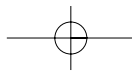

TO CHECK AUTO START TIME

Once you have correctly programmed oven for AUTO START, the present time will appear on the display.

1. Touch  pad.

The programmed AUTO START time will appear on the display for 3 seconds.

SPEEDY COOK

SPEEDY COOK allows you to reheat for 30 seconds at 100% (full power) by simply touching the SPEEDY COOK pad.

By repeatedly touching the SPEEDY COOK pad, you can also extend reheating time to 5 minutes by 30 second increments.

1. Touch  pad.

When you touch SPEEDY COOK, ":30" is displayed. After 1.5 seconds, the oven starts reheating.

ONE TOUCH COOKING

One touch cook allows you to cook or reheat many of your favorite foods by touching just one pad. To increase quantity, touch chosen pad until number in display is same as desired quantity to cook. (except for MUFFIN & DINNER PLATE)

1. Touch  pad
once for a 3.5 oz bag or twice for a
1.75 oz bag.

When you touch POPCORN pad once, "3.5" is displayed. After the 1.5 seconds, the display shows the cooking time and the oven starts cooking.

* POPCORN *

- 3.5 oz : Touch POPCORN once.
- 1.75 oz : Touch POPCORN twice within 1.5 seconds.

- NOTE:**
1. Use prepackaged room-temperature microwave popcorn.
 2. Place bag in oven according to manufacturer's directions.
 3. Pop only one bag at a time.
 4. After popping, open bag carefully, popcorn and steam are extremely hot.
 5. Do not reheat unpopped kernels or reuse bag.
 6. Do not leave oven unattended while popping popcorn.

CAUTION : If prepackaged popcorn is of a different weight than the recommended weight, do not use the popcorn pad. Follow the manufacturer instruction.

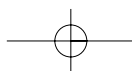

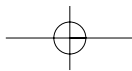

ONE TOUCH COOKING (CONTINUED)

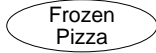
2. Touch  pad
once for a 7 oz pizza or twice for a
10 oz pizza.

When you touch FROZEN PIZZA pad once, "7" is displayed.
After 1.5 seconds, the display shows the cooking time and the
oven starts cooking.

* FROZEN PIZZA *

- 7 oz : Touch FROZEN PIZZA once.
- 10 oz : Touch FROZEN PIZZA twice within 1.5 seconds.

NOTE: 1. Use one frozen pizza at a time.
2. Use only frozen pizza made for microwave ovens.
3. If the cheese of frozen pizza does not melt sufficiently, cook a few seconds longer.
4. Some brands of frozen pizza may required more or less cooking time.

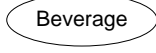
3. Touch  pad
once for 1 cup, twice for 2 cups or
three times for 3 cups.

When you touch BEVERAGE pad once, "1" is displayed.
After 1.5 seconds, the display changes into cooking time of
quantity and the oven starts cooking.

* BEVERAGE * (250ml/cup)

- 1 cup(mug) : Touch BEVERAGE once.
- 2 cups(mugs) : Touch BEVERAGE twice within 1.5 seconds.
- 3 cups(mugs) : Touch BEVERAGE three times within 1.5 seconds.

NOTE: 1. This setting is good for restoring cooled beverage to a better drinking temperature.
2. Stir after cooking.

4. Touch  pad
once for an 11 oz dinner plate of
food.

When you touch DINNER PLATE pad once, "11" is displayed.
After 1.5 seconds, the display shows the cooking time and the
oven starts cooking.

5. Touch  pad
once to cook 5 muffins.

When you touch MUFFIN pad once, "5" is displayed.
After 1.5 seconds, the display shows the cooking time and the
oven starts cooking.

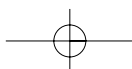

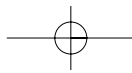

ONE TOUCH COOKING (CONTINUED)

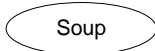
6. Touch  pad
once for a 8 oz soup or twice for a 12 oz.
- When you touch SOUP pad once, "8" is displayed.
After 1.5 seconds, the display shows the cooking time
and the oven starts cooking.

* SOUP*

- 8 oz : Touch SOUP once.
- 12 oz : Touch SOUP twice within 1.5 seconds.

7. Touch  pad
once for a 8 oz of fresh vegetable or twice
for a 12 oz of fresh vegetable.
- When you touch FRESH VEGETABLE pad once, "8" is
displayed.
After 1.5 seconds, the display shows the cooking time
and the oven starts cooking.

* FRESH VEGETABLE *

- 8 oz : Touch FRESH VEGETABLE once.
- 12 oz : Touch FRESH VEGETABLE twice within 1.5 seconds.

NOTE: For best results, consult the cookbook.

8. Touch  pad
once for each 5.5 oz ~ 6.5 oz baked
potato.
- When you touch BAKED POTATO pad once, "1" is
displayed.
After 1.5 seconds, the display shows cooking time and
the oven starts cooking.

* BAKED POTATO* (5.5 OZ~6.5 OZ/EA.)

- 1 NO(ea.) : Touch BAKED POTATO once.
- 2 NO(ea.) : Touch BAKED POTATO twice within 1.5 seconds.
- 3 NO(ea.) : Touch BAKED POTATO three times within 1.5 seconds.

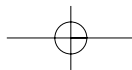

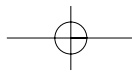

MORE, LESS

MORE pad: adds 10 seconds to 20 seconds.

LESS pad: removes 10 seconds to 20 seconds.

This pad only works with one touch cooking.
Always input prior to one touch sequence.

CHILD SAFETY LOCK

The safety lock prevents unwanted oven operation such as by small children.

To set, press and hold STOP/CLEAR for 3 seconds, LOCK indicator lights.

To cancel, press and hold STOP/CLEAR for 3 seconds, LOCK indicator goes off.

TO STOP THE OVEN WHILE THE OVEN IS OPERATING

1. Press STOP/CLEAR pad.
 - You can restart the oven by touching START pad.
 - Touch STOP/CLEAR once more to erase all instructions.
 - You must enter in new instructions.
2. Open the door.
 - You can restart the oven by closing the door and touching START.

<p>NOTE: Oven stops operating when door is opened.</p>

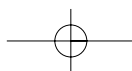

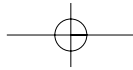

CARE OF YOUR MICROWAVE OVEN

- 1 Turn the oven off before cleaning.
- 2 Keep the inside of the oven clean. When food spatters or spilled liquids adhere to oven walls, wipe with a damp cloth. Mild detergent maybe used if the oven gets very dirty. The use of harsh detergent or abrasives is not recommended.
- 3 The outside oven surface should be cleaned with soap and water, rinsed and dried with a soft cloth. To prevent damage to the operating parts inside the oven, water should not be allowed to seep into the ventilation openings
- 4 If the Control Panel becomes wet, clean with a soft, dry cloth. Do not use harsh detergents or abrasives on Control Panel.
- 5 If steam accumulates inside or around the outside of the oven door, wipe with a soft cloth. This may occur when the microwave oven is operated under high humidity conditions and in no way indicates malfunction of the unit.
- 6 It is occasionally necessary to remove the glass tray for cleaning. Wash the tray in warm sudsy water or in a dishwasher.
- 7 The roller guide and oven cavity floor should be cleaned regularly to avoid excessive noise. Simply wipe the bottom surface of the oven with mild detergent water or window cleaner and dry. The roller guide may be washed in mild sudsy water.

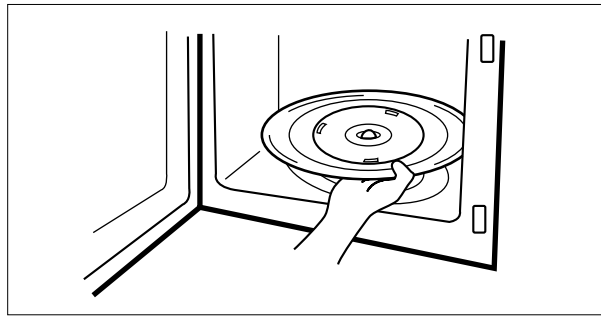

ROLLER GUIDE

1. The ROLLER GUIDE and oven floor should be cleaned frequently to prevent excessive noise.
2. The ROLLER GUIDE MUST ALWAYS be used for cooking together with the Glass Tray.

GLASS TRAY

1. DO NOT operate the oven without the Glass Tray in place.
2. DO NOT use any other Glass Tray with this oven.
3. If Glass Tray is hot, ALLOW TO COOL before cleaning or placing it in water.
4. DO NOT cook directly on the Glass Tray.

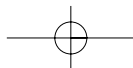
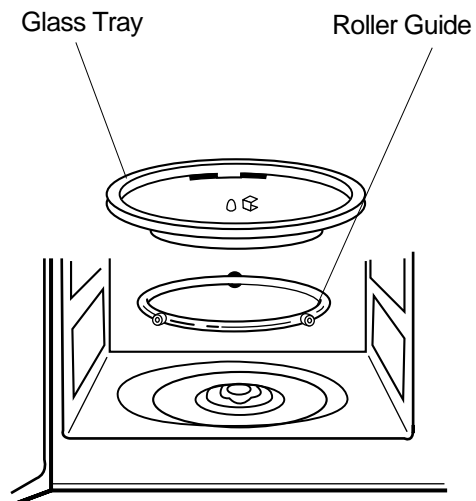

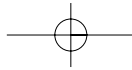

Warranty



DAEWOO ELECTRONICS CORPORATION OF AMERICA warrants each new electronic product manufactured by it to be free from defective material and workmanship and agrees to remedy any such defect or to furnish a new part (at the Company's option) in exchange for any part of any unit of its manufacture which under normal installation, use, and service disclosed such defect, provided the unit is delivered by the owner to us or to our authorized distributor from whom purchased or authorized service station, intact, for our examination with all transportation charges prepaid to our factory, To establish and receive warranty service at our factory or authorized service facilities, proof of purchase/dated sales invoice is required

Return authorization must be obtained before any merchandise is returned to the factory.

This warranty does not extend to any of our electronic products which have been subjected to misuse, neglect, accident, incorrect wiring not our own, improper installation, unauthorized modification, or to use in violation of instructions furnished by us, nor units which have been repaired or altered outside of our factory, nor to cases where the serial number thereof has been removed, defaced, or changed

This warranty is in lieu of all warranties expressed or implied and no representative or person is authorized to assume for us any other liability in connection with the sale of our electronic products.

Over-the-counter exchange for units that are initially defective.

"Initially defective" is described as when the dealer opens the unit and finds that it is inoperative or a customer opens a new unit and finds that it is inoperable. This unit may be returned to the factory by the dealer for exchange. Under no circumstances will the customer be permitted to return the defective unit directly to the factory.

Exchange must be directly with the dealer.

Model	Parts	Labor	Magnetron
MCM660A	1 year	1 year	8 years

For Service or Assistance, please call : 1-800-553-4355

